



GLOBAL PRESENCE

plantlogic
innovative products
for smart growers



USA
+1 (213) 222 6433



Australia
+86 159 0674 1627

CATALOG 2025

GETPLANTLOGIC.COM



INCREASE
YIELD



IMPROVE
CONTROL



SAVE
MONEY

Innovative products for smart growers

Plantlogic was founded when a berry grower asked if we could make a better pot for growing blueberries. Ever since then we've solved problems by designing solutions for commercial substrate growers. Over the years we've helped substrate growers of cannabis, flowers, rubus, vegetables, and strawberries. We've maximized drainage and ensured optimal oxygen uptake. All the while we continuously improve our products' durability, quality, and design.

At Plantlogic we never stop innovating. What can we do for you?

As we've expanded into new fields, we have also deepened our roots by growing our line of products to include drainage collection pots, round and square pots, growing systems and a robust assortment of accessories. We're proud to provide the equipment needed to help professional growers be successful.

With operations and staff spanning five continents, we have achieved the size and scale to meet our customers where they're at. Customer satisfaction lies at the heart of everything we do, which is why we have invested in building local field sales teams in all our areas

of operation. We have staff in Mexico, Peru, US, China and Africa. Our sales teams are committed to understanding the unique needs of our customers. We make the investment in visiting our customers' farms so we can provide the best solutions for their needs. Sometimes that means customizing existing products, or even developing totally new products.

Turning great ideas into great products is our passion. Working with our customers to solve their problems is how we got our start in this business and how we continue to operate to this day.

So, whether you're seeking to optimize your yields, minimize water usage, improve disease management, or just generally seeking to reduce operational risk in your growing environment, our team has the expertise and knowledge to build the right solution to fit your needs and budget.

Global mindset + Global partnerships = Maximum value for our customers

We also believe that we can bring more value to your farm beyond growing containers. Our global field sales team and distributors has built a network of partnerships across the world, and by working with us, you gain access to that community of knowledge. By connecting our customers with great ideas, new perspectives, and even each other, we're able to bring a level of value that our competitors cannot match.

How do we achieve that value for our customers? First, we make the effort to understand our customers' needs.

We truly believe that we know our customers better than any of our competitors do. Our local field sales teams regularly visit our customers farms and listen to how their needs are evolving. We use high quality material blends designed to outlast your plants, and can be used for multiple seasons and planting cycles,

so we can confidently offer an industry-leading warranty.

Second, by investing in a global logistics team we are able to efficiently deliver to our customers' farms, saving time, money and headaches. Because we manufacture our products ourselves, we have full control over the manufacturing process and greater manufacturing capacity than our peers. Simply put, we can make more products, faster, than anyone else on the market. Ultimately we work to gain and keep the trust of our customers founded upon mutual respect, honesty, and accountability. Keeping our word will always be our promise and commitment to you.

We love to help growers solve their greatest problems. What can we solve for you today?



Visit getplantlogic.com/contact-us/
and let us know!

Quality of our products



Our pots are manufactured by completely automated machinery. We use only high-quality raw materials to ensure we meet the highest possible production standards.



We guarantee pots that will outlive your plants.



Consistent quality throughout our products makes them reusable cycle after cycle.

Index of products



Blueberry production

Page 4



Vegetable production

Page 31



Rubus production

Page 11



Cooling options

Page 38



Cannabis production

Page 16



Lysimeters

Page 40



Strawberry growing systems

Page 19



Bag bases

Page 42

Dimensions

A - Product height

B - Top outside dimensions

C - Bottom dimensions

D - Legs height

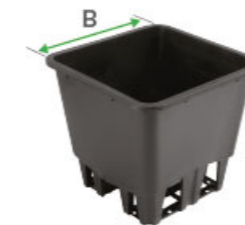

* All images and descriptions are subject to typing and printing errors. Plantlogic can not be held liable for this and these errors are not binding.



BLUEBERRY PRODUCTION

Plantlogic's pots are specially designed to maximize drainage and oxygen uptake to support healthy roots and plant vigor.

Blueberry production

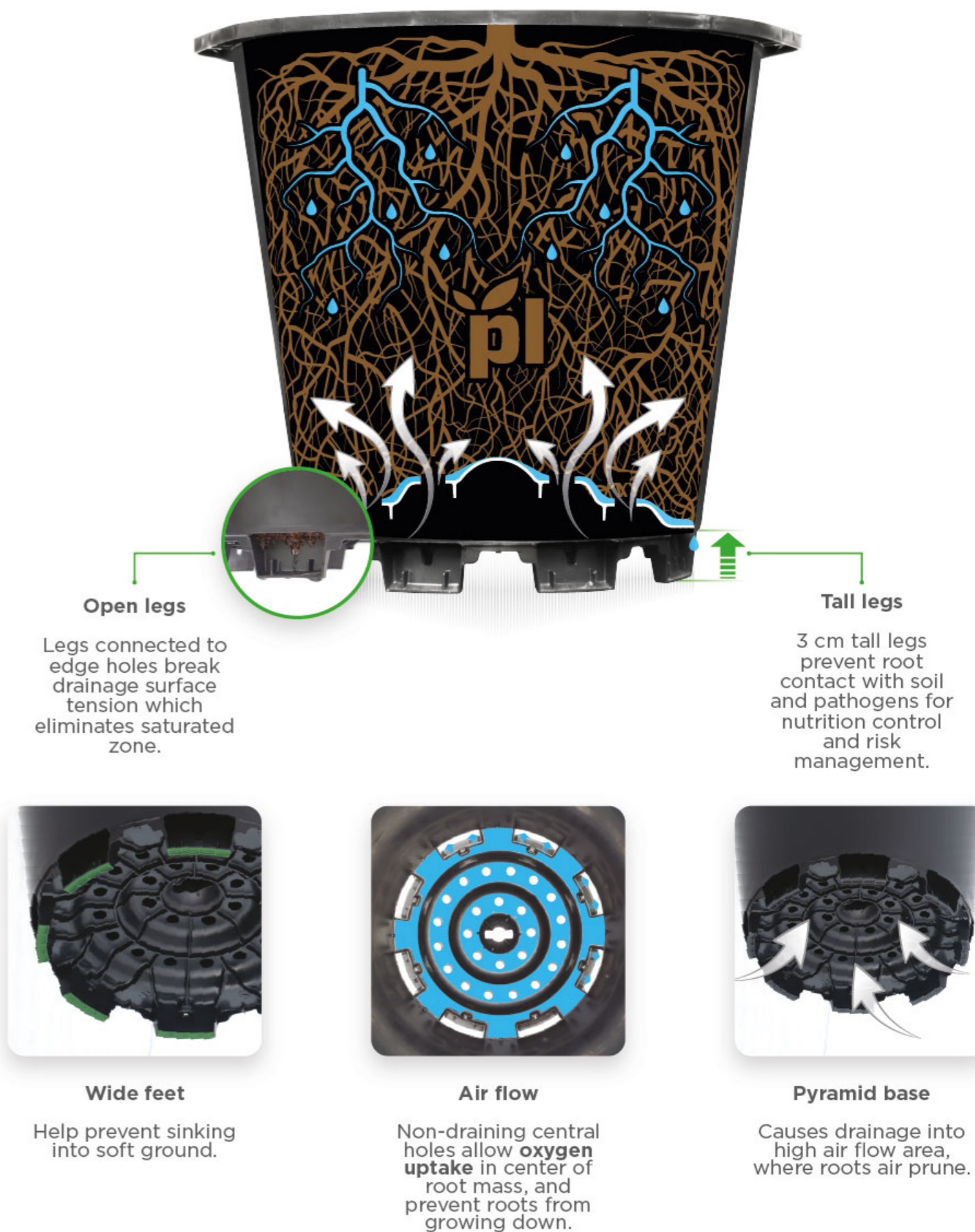

Blueberry production



Available colors: Black White Terracotta

Dimensions

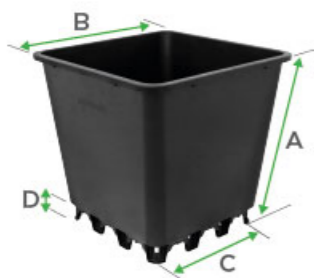

		A	B	C	D
1309020	20L Square Pot With Legs	316 mm	330 x 330 mm	229 mm	30 mm
1308020	20L Round Pot With Legs	303 mm	∅ 370 mm	245 mm	30 mm
1303025	25L Round Pot With Short Legs	306 mm	∅ 399 mm	294 mm	13 mm
1308025	25L Round Pot With Legs	354 mm	∅ 385 mm	268 mm	30 mm
1309025	25L Square Pot With Legs	322 mm	355 x 355 mm	264 mm	30 mm

Blueberry production

Three different U-groove spacing options for irrigation pipes.



Dimensions

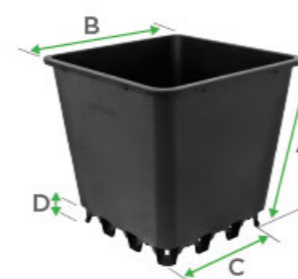

		A	B	C	D
1309026	25L Square Pot With U-grooves	322 mm	355 x 355 mm	264 mm	30 mm
1304125	25L Round Drainage Collection Pot	320 mm	∅ 420 mm	275 mm	70 mm
1303125	25L Drainage Collection Pot With Short Legs	298.5 mm	∅ 399 mm	300 mm	20 mm
1308303	30L Round Pot With Legs and U-grooves	380 mm	∅ 407 mm	283 mm	30 mm
1308031	30L Round Pot With Legs and V-rib	383 mm	∅ 407 mm	282 mm	30 mm
1309030	30L Square Pot With Legs	322 mm	385 x 385 mm	291 mm	30 mm
1309035	35L Square Pot With U-grooves	350 mm	425 x 425 mm	290 mm	40 mm
1308040	40L Round Pot With Legs	384 mm	∅ 460 mm	330 mm	30 mm
13080410	40L Round Pot With Legs And U-grooves	384 mm	∅ 460 mm	330 mm	30 mm

Blueberry production



30L



30L



40L

i Available colors:



Black White Terracotta



Add value to your pots with:



Cooling skirt
See page 39.



Hose clips
See page 41.

Blueberry production

Zephyr V2

Customizable hole density

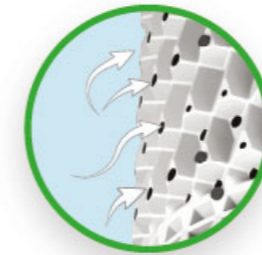

More aeration

Tallest legs in the world
7 cm legs.

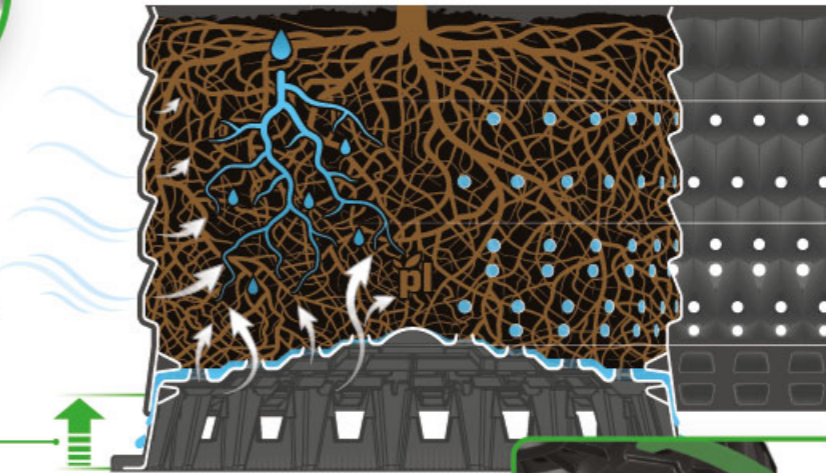

Stable base with large surface area
Wide base is 5x more stable than any other pot with legs.

No aeration holes
Substrate on top maintains the adequate amount of moisture.

1x aeration holes

2x aeration holes
At the bottom of the pot wall for better airflow and oxygenation.



Strong connection

Gear slots are specially designed for greater base and wall support.



Excellent drainage

Pyramid base forces water to drain at the outside edges, which minimizes wet zone.

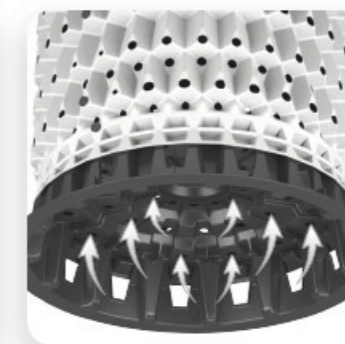

Air flow and oxygenation

Non-draining central holes allow **oxygen uptake** in center of root mass, and prevent roots from growing down.



Unique wall design

Side wall shape helps prevent compacting and root spiraling improving root architecture.

Blueberry production



Unique drainage flow
Without leaking substrate.



Available colors: Black White

Capacities:
25L | 30L | 40L

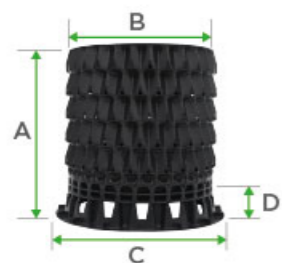

		A	B	C	D
1301144	25L Zephyr pot with 7 cm legs	369 mm	∅ 333 mm	397 mm	70 mm
1301153	30L Zephyr pot with 7 cm legs	420 mm	∅ 333 mm	397 mm	70 mm
1301143	40L Zephyr pot with 7 cm legs	370 mm	∅ 427 mm	500 mm	70 mm



RUBUS PRODUCTION

Plantlogic's pots are specially designed to maximize drainage and oxygen uptake to support healthy roots and plant vigor.

Rubus production



U-Grooves

Keep your irrigation pipe in place with our U-groove function.

3 cm tall legs prevent root contact with soil and pathogens.



Hooks for stabilization

Handles easily hooks to trellis wire, which stabilizes pots to prevent tip overs of young canes.

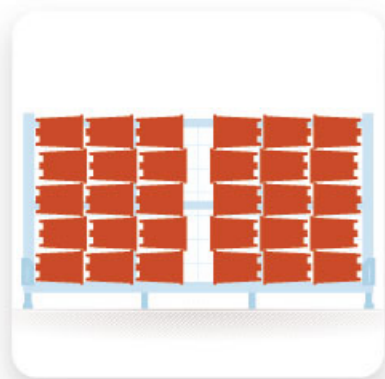

High cold storage efficiency

Allows more units per bin.

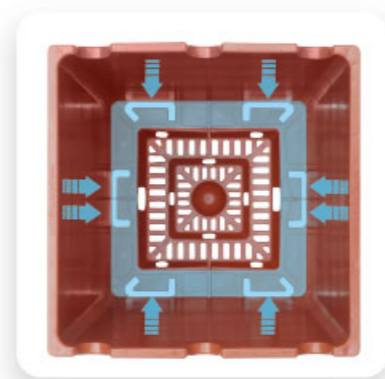

Pyramid base

Causes drainage into high air flow area, where roots air prune.



Air flow

Non-draining central holes allow **oxygen uptake** in center of root mass, and prevent roots from growing down.

Rubus production



Specialized pots for long cane and cold storage

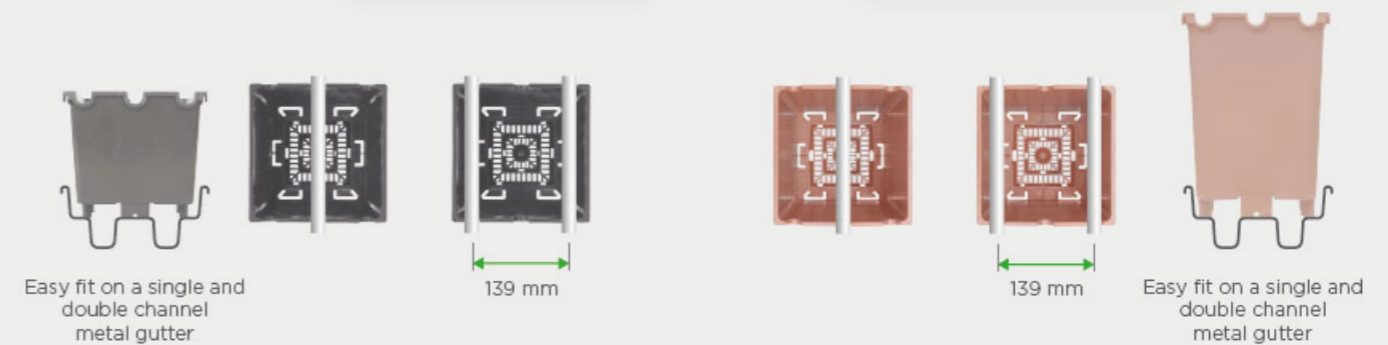
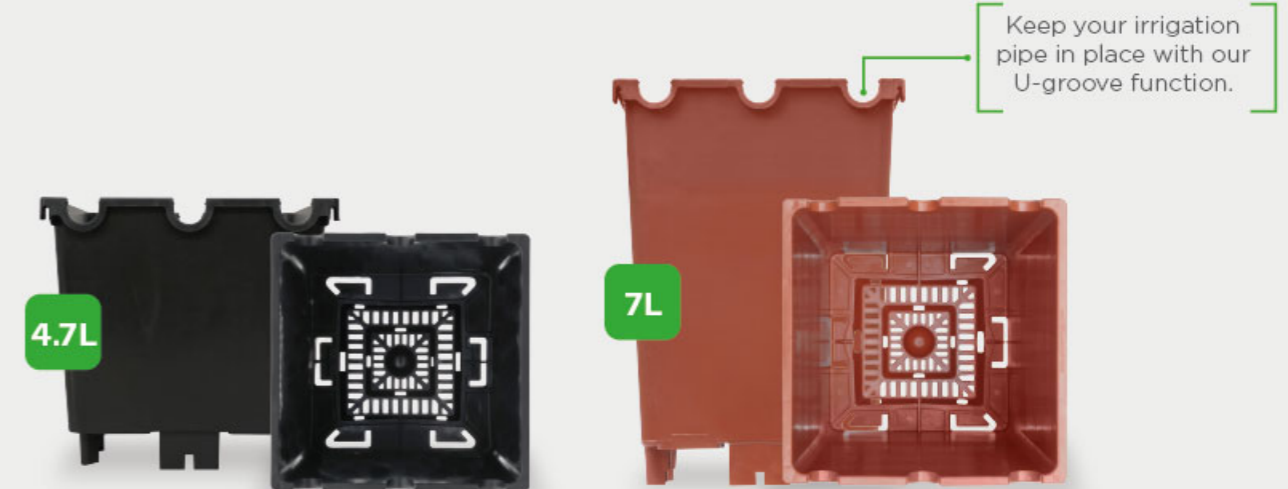

Dimensions



	A	B	C	D
1306003 3L Square Pot With Legs	200 mm	150 x 150 mm	112 mm	20 mm
1305004 4.7L Square Pot For Cold Storage	187 mm	198 x 198 mm	156 mm	25 mm
1306051 5L Square Pot With Legs	202 mm	204 x 204 mm	154 mm	30 mm
1305005 5L Square Drainage Collection Pot	191 mm	208 x 208 mm	163 mm	40 mm
1305071 7L Square Pot For Cold Storage	272 mm	197 x 197 mm	156 mm	30 mm

Rubus production



Available colors: Black White Terracotta

Dimensions

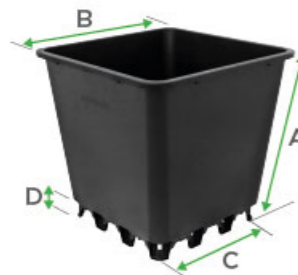

		A	B	C	D
1306007	7L Square Pot With Legs	285 mm	201 x 201 mm	140 mm	30 mm
1307107	7L Square Drainage Collection Pot	295 mm	201 x 201 mm	136 mm	70 mm
1309008	8L Square Pot With Legs	212 mm	256 x 256 mm	181 mm	25 mm
1306010	10L Square Pot with Legs	245 mm	276 x 276 mm	189 mm	30 mm
1307110	10L Square Drainage Collection Pot	256 mm	288 x 288 mm	198 mm	70 mm
1309015	15L Square Pot With Legs	338 mm	288 x 288 mm	202 mm	50 mm
1304115	15L Round Drainage Collection Pot	329 mm	∅ 330 mm	193 mm	70 mm
1308303	30L Round Pot With Legs And U-grooves	380 mm	407 x 407 mm	283 mm	30 mm

Rubus production



Add value to your pots with:



Cooling skirts
See page 39.



Gutter
See page 44.



Pot cover
See page 45.

CANNABIS PRODUCTION



Plantlogic's drainage collection (DC) pots direct water flow into a narrow gutter which channels drainage out of the growing area. DC pots help control humidity inside tunnels and greenhouses. Also avoid environmental impact of drainage.

Cannabis production Drainage collection

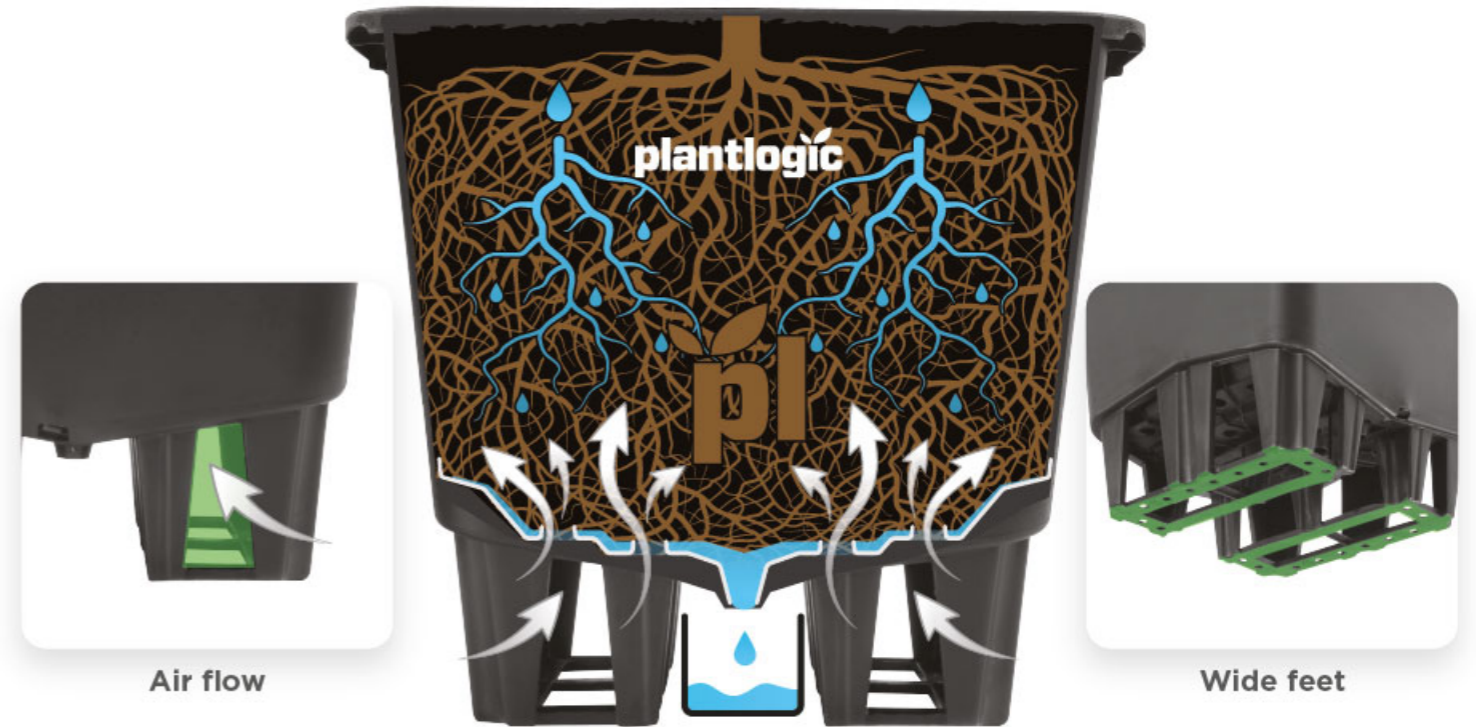

Air flow

Non-draining side holes allow **oxygen uptake** in center of root mass, and prevent growing down.

Wide feet

These promote stability even on soft ground.

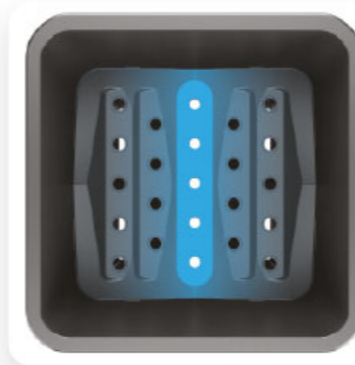

Excellent drainage

Our unique base design forces water to drain from the center holes, minimizing the wet zone.



100% drainage collection

Keeps ground free of water and fertilizer by **collecting all drainage** into an economical gutter. Avoids debris and algae buildup in gutter.



Tall legs

Prevent root contact with soil and pathogens.

Cannabis production

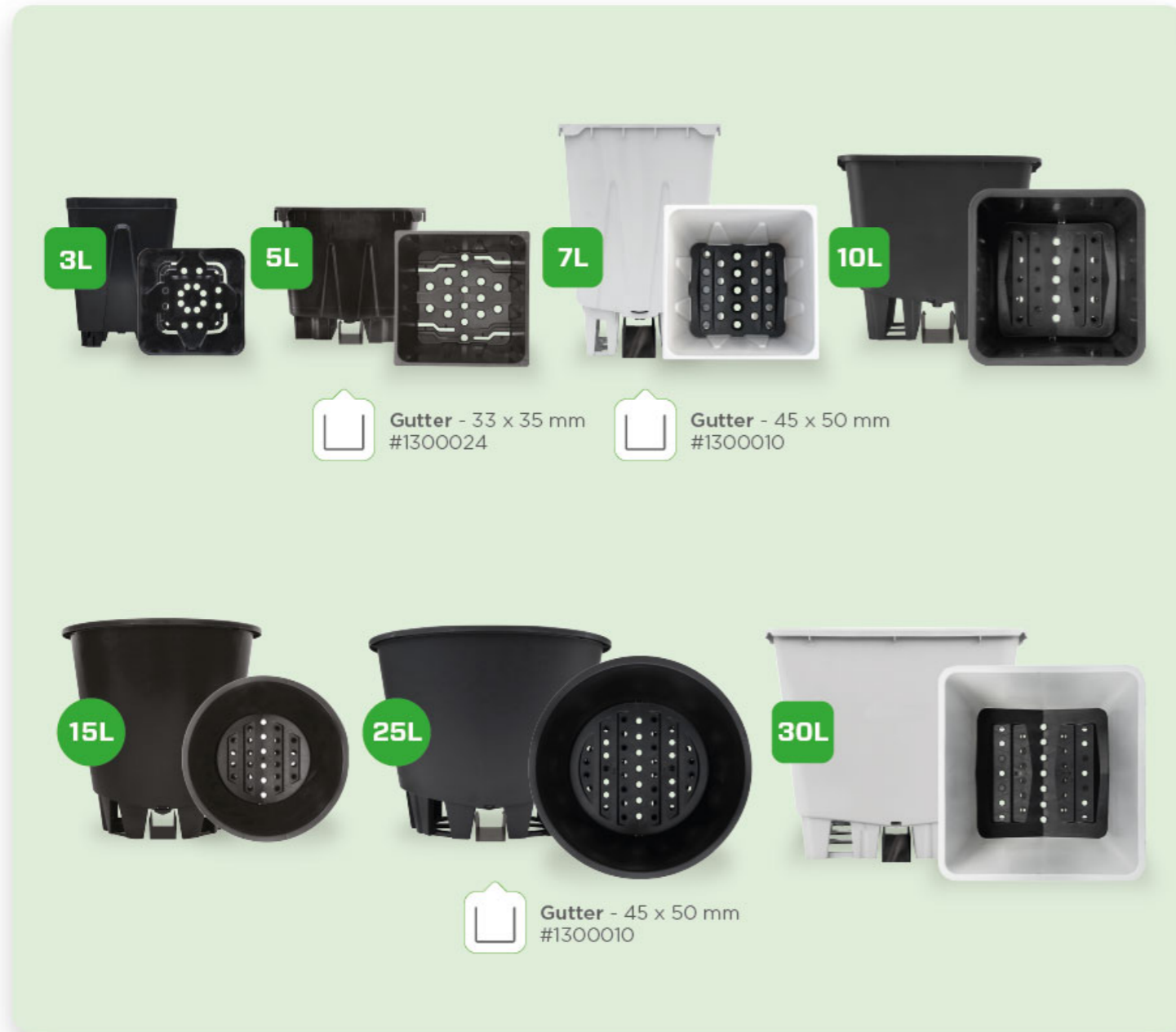

Available colors: Black White Terracotta

Dimensions



		A	B	C	D
1305005	5L Square Drainage Collection Pot	191 mm	208 x 208 mm	163 mm	40 mm
1307107	7L Square Drainage Collection Pot	295 mm	206.1 x 205.3 mm	136 mm	70 mm
1307110	10L Square Drainage Collection Pot	256 mm	288 x 288 mm	198 mm	70 mm
1304015	15L Round Drainage Collection Pot	329 mm	∅ 330 mm	193 mm	70 mm
1304125	25L Round Drainage Collection Pot	320 mm	∅ 420 mm	276 mm	70 mm
1307133	30L Square Drainage Collection Pot	343 mm	386 x 386 mm	290 mm	70 mm

GETPLANTLOGIC.COM



STRAWBERRY PRODUCTION

Cost-effective and low maintenance, Plantlogic's Hi-Grow system makes it easy and comfortable to grow, care for, and harvest strawberries.

Strawberry production growing systems

Effective for strawberry production

Our Hi-Grow strawberry growing system was developed from the ground up based on the fundamentals of substrate production – standardize, control, improve oxygenation and drainage, separate roots from drainage, all while reducing capital costs. We broke the tradition of using expensive metal gutters when we developed our breakthrough product. We not only reduce costs but increase quality.

Designed to lower cost while increasing yield.

Our latest system includes several versions from our lowest priced to our premium product built with snap together metal tubes. Available in hanging and tabletop versions, our Hi-Grow system can support

troughs or slabs, is available with or without drainage collection, and can support inline drippers as well as drip stakes.

Using our totally new design of separating the container support structure from the drainage, Plantlogic's Hi-grow system is more cost-effective than traditional metal gutter systems, using about 27% less steel.

Easy installation and labor savings

Hi-Grow system installation is quicker and easier compared to traditional metal gutters, requiring a smaller installation team to efficiently install.

This new design does not require land leveling or precision post grading to ensure drainage flows, which simplifies installation and reduces initial costs.



▶ Scan
To watch video

Tabletop system - Trough version



Wire clips
Specially designed for inline or lateral irrigation.



Maximize airflow and oxygenation



Adjustable slope for drainage using the gutter bracket.

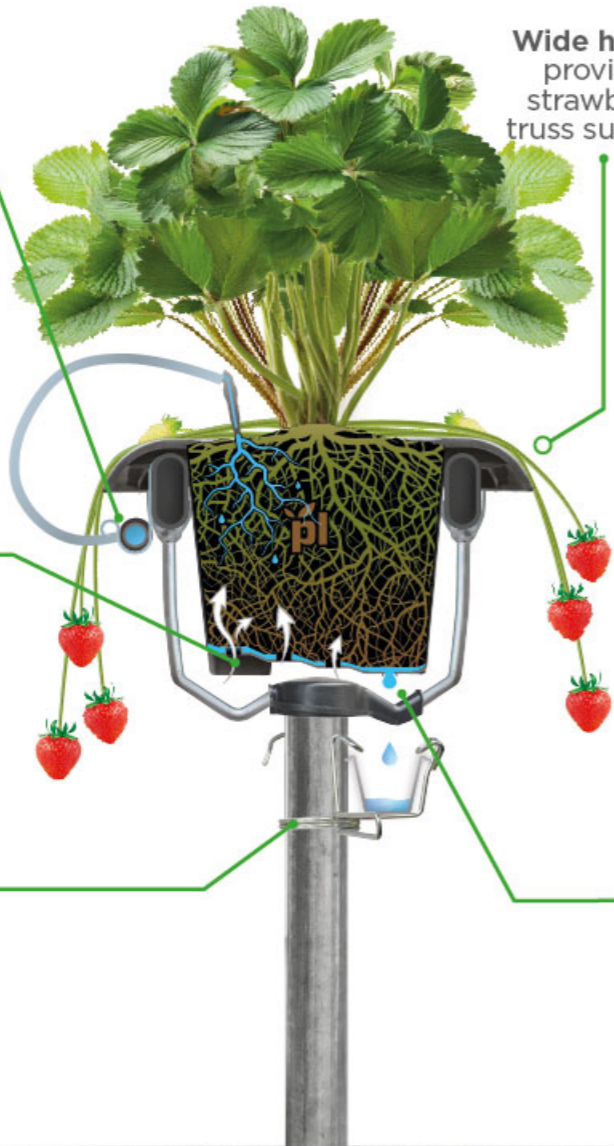

Wide handle provides strawberry truss support.



Cost less than other tabletop substrate systems.



Optional drainage collection
Helps control humidity in greenhouses and tunnels.



Excellent drainage

Tabletop system set-up
Trough version

18L Trough

Rail

Post cover

Y Bracket

Gutter

Gutter end cap

Gutter bracket

Post

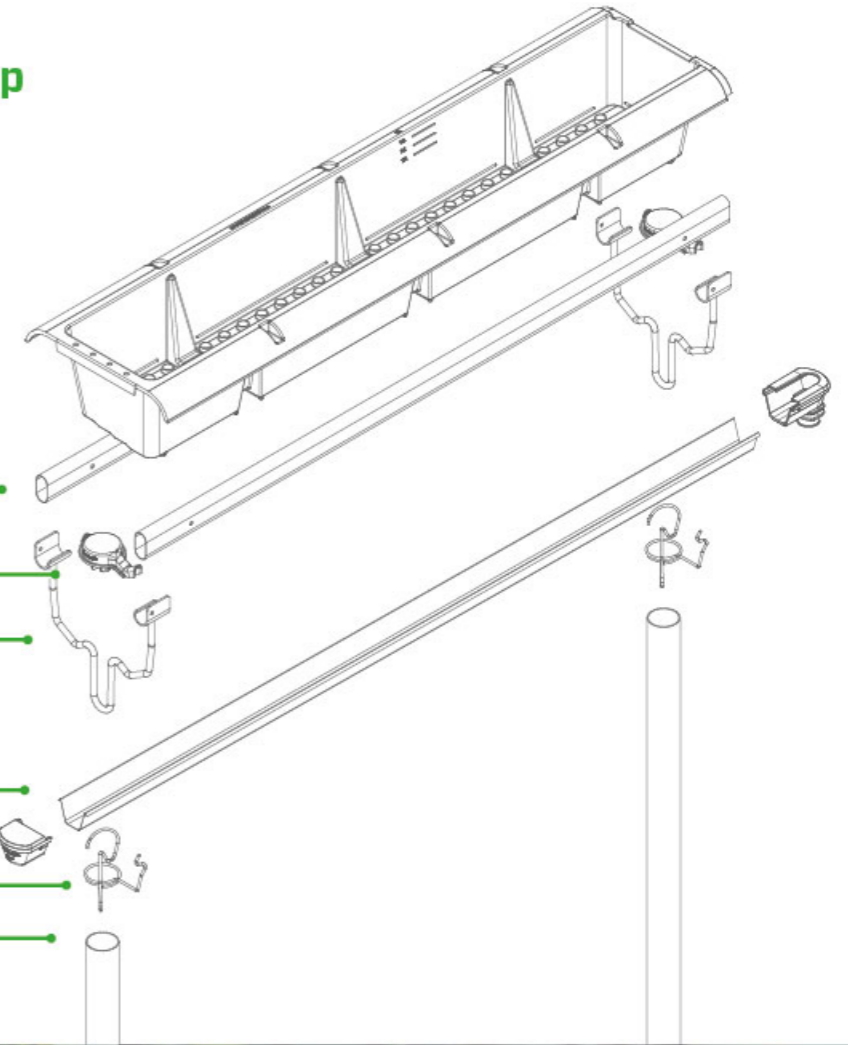

Adjustable gutter slope

3 m distance between posts

Tops of posts don't require precision grading because the gutter slope is independently adjustable.

More economical than traditional systems (27% less metal).

Optional drainage collection.

The drainage system is separate from the planting system, making installation easier and reducing disease risk.



Tabletop system - Slab version



Maximize airflow and oxygenation



Lower upfront capital expense.



Hose clips specially designed for lateral irrigation



Excellent drainage



Adjustable slope for drainage using the gutter bracket.



Optional drainage collection
Helps control humidity in greenhouses and tunnels.



Adjustable gutter slope

3 m distance between posts

Tops of posts don't require precision grading because the gutter slope is independently adjustable.

More economical than traditional systems (27% less metal).

Optional drainage collection.

The drainage system is separate from the planting system, making installation easier and reducing disease risk.



**Tabletop system set-up
Slab version**

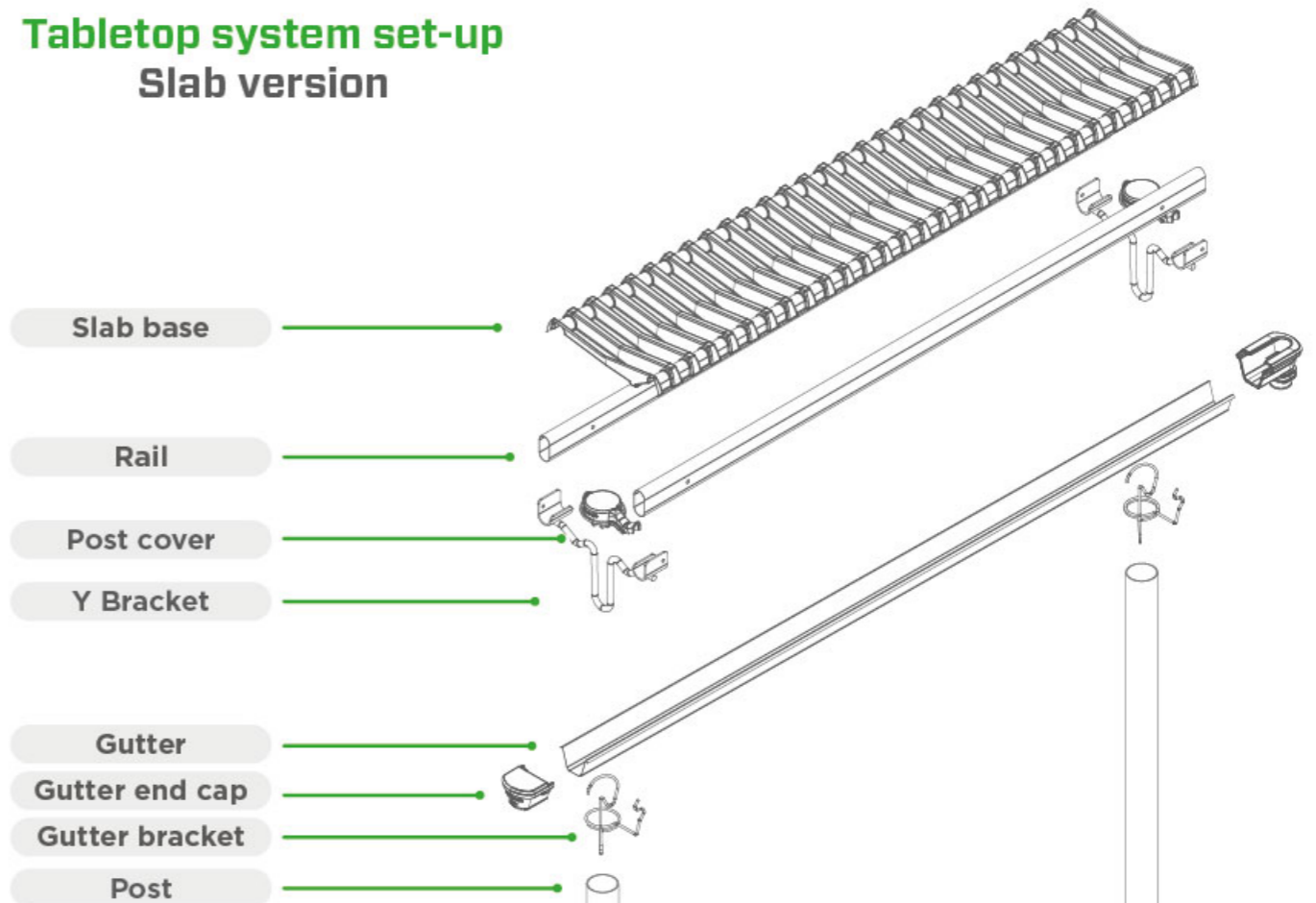

Hanging system - Trough version

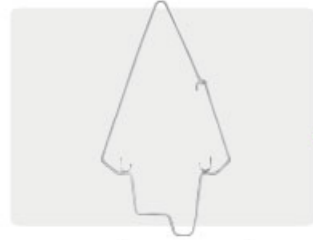

Hanging bracket
100% customizable to each grower's needs.

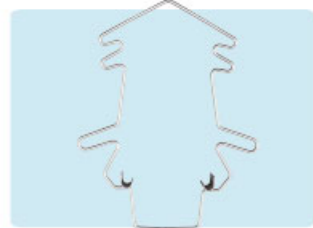

Optional bracket
available for truss support tape and leaf-fruit separation.



Maximize airflow and oxygenation



Chain or steel wire
available.



Pot system can be switched to slabs.



Excellent drainage

More economical than traditional systems.

Optional drainage collection.

The drainage system is separate from the planting system, making installation easier and reducing disease risk.

Hanging system - Slab version

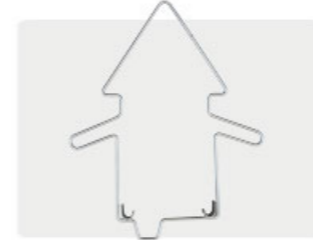

Hanging bracket
100% customizable to each grower's needs.



Optional bracket
available for truss support tape and leaf-fruit separation.



Maximize airflow and oxygenation



Chain or steel wire
available.



Lower upfront capital expense.



Excellent drainage

More economical than traditional systems.

Optional drainage collection.

The drainage system is separate from the planting system, making installation easier and reducing disease risk.



Add value to your system

Plastic gutter bracket



Metal gutter bracket



Holds the gutter in its place and controls the drainage slope for the system.

Plastic anti-sinking plate



Metal anti-sinking plate



Prevents sinking of the post in soft or humid soil.

32 mm post cap



42 mm post cap



Keeps drainage from damaging the post.

PE trough cover



Helps maintain substrate humidity and reduces the use of drip stakes.

Metal gutter



Narrow gutter keeps ground free of water by collecting all drainage.

Hi-Grow lysimeter



Exclusive tool for accurate drainage for leachate monitoring.

Containers for Hi-Grow System

9L Trough with truss support



18L Trough with truss support



Slab base



Dimensions



		A	B	C
1305409	9L Trough For Strawberries, With Truss Support	156 mm	257 mm	511 mm
1305909	18L Trough For Strawberries, With Truss Support	142 mm	165 mm	1014 mm
1302809	Slab base	-	185 mm	-



VEGETABLE PRODUCTION

Plantlogic's substrate slab bases provide greater benefits and savings per linear meter compared to other flat spacers and wide gutters on the market which makes them ideal for growing tomatoes, peppers, cucumbers, and other vegetables in grow bags.

Vegetable production

Substrate slab bases

Maximize your vegetable production with Kratos

Kratos is a growing system that consists of a V-shaped base with 9.5 cm height that keeps grow bags and slabs off the ground. The narrow gutter collects all drainage water under the bags. Kratos' narrow gutter is cheaper and cleaner (leaves and fruit cannot fall into the narrow gutter) and it's also easier to manage and drainage flows much better than traditional wide gutters.

Kratos is more economical than the traditional spacer and wide gutter system and much easier to install. Additionally, unlike other spacers in the market whose legs easily break or their bases collapse with the weight of bags, Kratos is made using our high quality material blend, designed to last for years of planting and disinfection cycles.

Rivus is double functionality at the best price

Rivus is a 2-in-1 spacer that works as a base for the bags and as a drainage collection gutter. Its 6 cm tall platform keeps roots out of drainage and push drainage to the edges, providing more consistent moisture distribution across the grow bags. Open airflow underneath keeps roots off the ground and prevents contact with pathogens.

Rivus' main advantage over other spacers in the market is its built-in gutter that keeps the floor of your greenhouse free of puddles and allows the reuse of excess water. In addition, price per linear meter is cheaper compared to other plastic spacers and traditional wide gutter. Installation is easy and simple.



Kratos slab base

The Kratos, with its unique and exclusive V-shaped design, channels all drain water into a narrow gutter which runs under the center of the spacer. The open space between the slab and the gutter provides aeration and prevents the roots from growing out of the slab and into contact with drainage water.

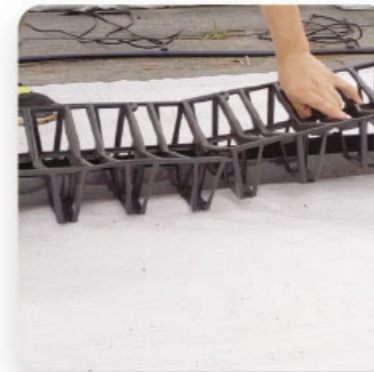

Simple to use

Easy and fast installation. Easy to wash and disinfect.



Clean

Fruits and leaves can't fall into the gutter.



Narrow gutter

Keeps ground free of water by collecting all drainage below the slab, avoiding the dirt buildup and algae formation common in wide gutters.

Durable

UV stabilized.

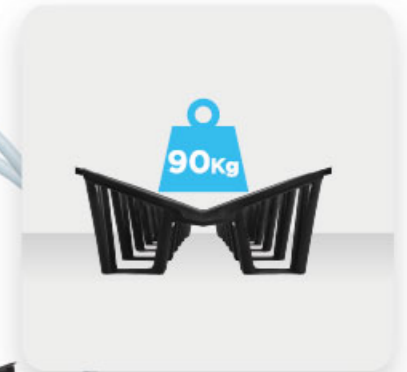

Supports up to 90 kg/meter.



Airflow and Oxygenation

Keeps roots off the ground and out of the gutter, preventing contact with pathogens.

Dimensions

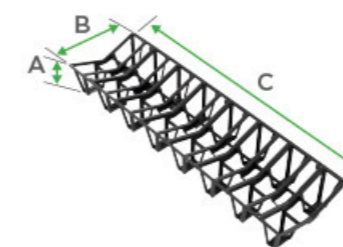

Plastic gutter

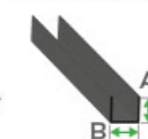

Metal gutter

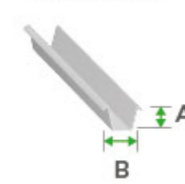

		A	B	C
1301081	Kratos slab base	95 mm	222 mm	750 mm
1300011	Plastic gutter	35 mm	50 mm	-
30050008	Metal gutter	59 mm	33 mm	-

Rivus 2-in-1 slab base

The Rivus, with its unique 2-in-1 design, works as a base and as drainage collection gutter. This enhances the performance of grow bags and slabs by providing them with greater oxygenation and uniform drainage.

Rivus costs much less than other plastic and metal gutters and it is delivered to your farm in 2, 4 or 8-meter pieces which overlap one on top of the other to fit any length.

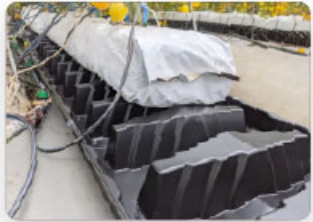

One piece base for even drainage into build-in gutter.

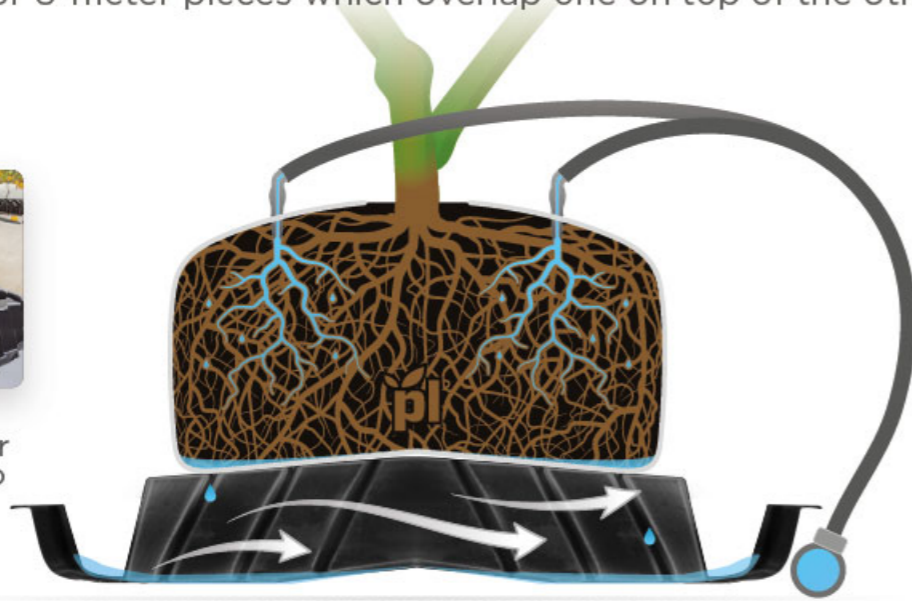

60 mm tall platform

Keeps roots out of the drainage and pushes drainage to the edges.



Cost-effective

More economical than wide gutter and spacer.



One piece design

Is easy to install and maintain.



Airflow and Oxygenation

Open airflow underneath keeps roots off the ground and prevents contact with pathogens.

*Supports up to 60 kg/meter.

Dimensions

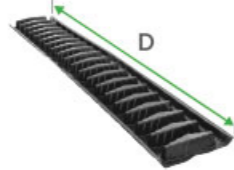

Available colors: Black White

		A	B	C	D
13020500	Rivus slab base - Black	60 mm	320 mm	205 mm	2, 4, 8 m
13020502	Rivus slab base - Black and white	60 mm	320 mm	205 mm	2, 4, 8 m
13020510	Rivus end cap - Black	60 mm	320 mm	205 mm	-
13020512	Rivus end cap - Black and white	60 mm	320 mm	205 mm	-



Specialized pots for vegetable production

10L Drainage collection pot



17L Drainage collection pot



25L Drainage collection pot



Dimensions

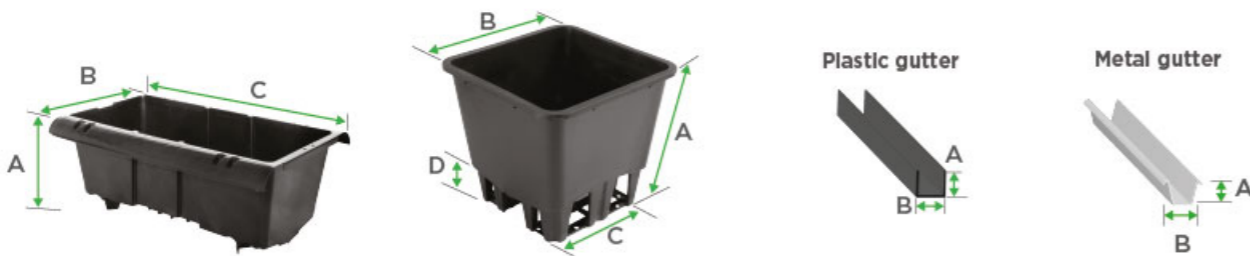

		A	B	C	D
1307110	10L Drainage collection pot	256 mm	288 mm	288 mm	70 mm
1305117	17L Drainage collection pot	201.8 mm	325.6 mm	511.9 mm	-
1304125	25L Drainage collection pot	320 mm	Ø 420 mm	Ø 420 mm	70 mm
1300010	Plastic gutter	45 mm	50 mm	-	-
30050008	Metal gutter	59 mm	33 mm	-	-



ADD VALUE TO YOUR PRODUCTS

Discover our accessories and enhance your growth with our innovative solutions.



Cooling options for high solar radiation zones

- Provide shade to the roots.
- Allow air flow under the pot.
- Reduce root temperature.
- Available in custom colors.
- Promote even root development and prevent salt accumulation.
- Save water and simplify irrigation. No need to use irrigation water just to cool roots.
- Reduce the temperature by up to 10 degrees Celsius.



Pot temperature without cooling skirt.



Pot temperature with cooling skirt.



Pot temperature with cooling skirt raised.

Cooling options



Cooling skirt

Adjustable, can be lowered or raised with hose clip, to heat/cool the pots.

Reduce the temperature by up to 10 degrees Celsius.

Cooling skirt doesn't block air flow under pot.

Cooling strip

The cooling strip comes with a built-in PET rope, which can be fixed to the posts.

The length can be customized according to the requirements.



Pot cover

Prevents weed growth.

Shades pot and substrate on top, keeping it cool.

Cools the pot, even the substrate on top to keep it wet.





Lysimeters

Lysimeters kit

Drainage flows directly into closed container to provide accurate and clean drainage samples for measuring drainage volume, pH and EC.

Lysimeters kit includes IN for drip and OUT for leachate buckets.



Lysimeters

Low cost tool for accurate drainage for leachate monitoring.



Item #1301010



Item #1301030

Dimensions

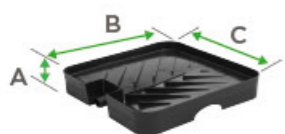

		A	B	C
1301010	Small lysimeter	35 mm	216 mm	216 mm
1301030	Large lysimeter	38 mm	316 mm	316 mm

Hose clips

UPDATED DESIGN!



Metal wire clip

Holds and secures irrigation pipe and keeps hose in place.

Improved design is easier to install, perfectly fits pipes.

Elevates emitter, micro tube and hose off the ground, keeps them from being damaged or pulled out.



▶ Scan
To watch video



16 mm clip
Item #1205012



20 mm clip
Item #1205015

Hose clip for Zephyr V2

Keeps the irrigation hose in place.

Reduces chance of damage to micro tube, stake and emitters by raising off the ground and away from worker traffic.

With support for guide wire.



Item #1700149



Hose clips

Holds irrigation pipe.

Holds cooling skirt in place.

Saves money by using more than 50% less micro tubing.

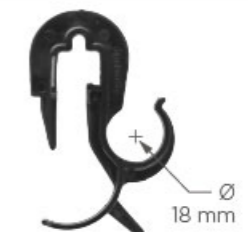

Item #1205001



Item #1205002

Bag bases



NEW PRODUCT!

VF bag base

Low-cost base for Grow Bags.

50 mm tall platform. Keeps roots out of the drainage and promotes efficient drainage.

Unique sloped structure design. Allows grow bags to sit stably on the base.

Low cost. More economical than rigid bases whose legs easily break or their bases collapse with the weight of bags.

Item #12010300

Dimensions

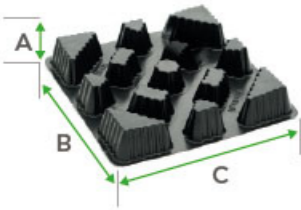

	A	B	C
12010300 VF Bag base	50 mm	320 mm	320 mm

Drainage collection bag base

Base for growing bags.

Gutter - 45 x 50 mm
#1300010

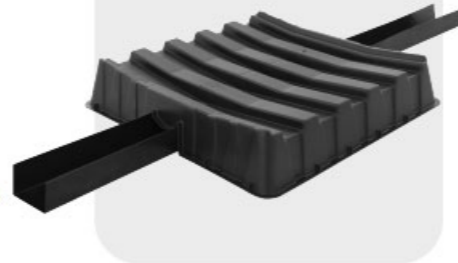

Dimensions

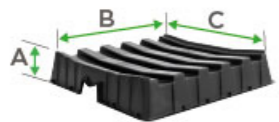

	A	B	C
1301036 Bag Base, for Drainage Collection	65 mm	372 mm	372 mm



GETPLANTLOGIC.COM

Culti-base

Grow bag with integrated base

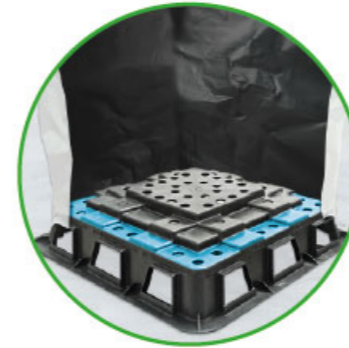

Pyramid base

Forces water to drain at the outside edges, minimizing the wet zone.



Air flow

Non-draining central holes allow oxygen uptake in the center of root mass and prevent roots from growing down.

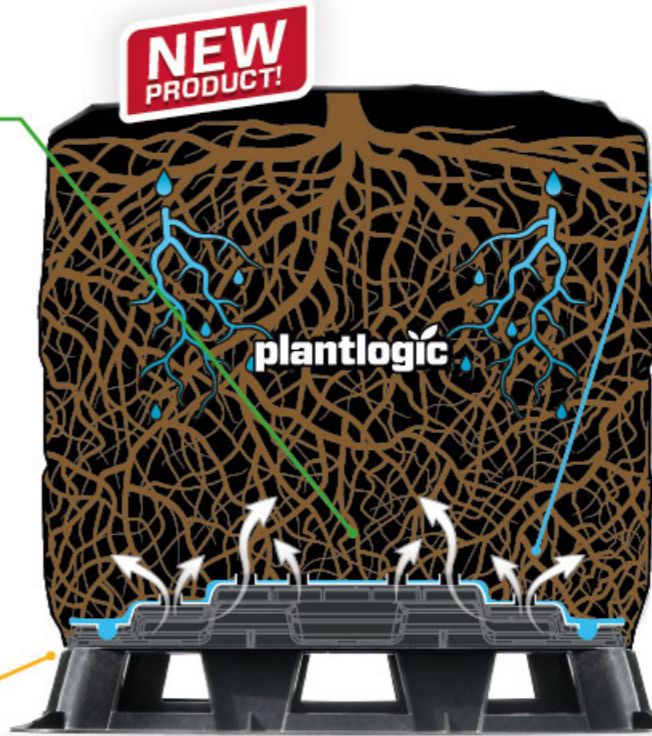

NEW PRODUCT!

plantlogic



5 cm tall legs

Prevent root contact with soil and pathogens for nutrition control and risk management.



Supports up to 90 kg



Stable base

With large surface area promotes stability even on soft ground.

Dimensions

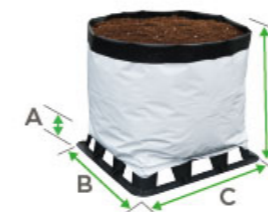

	A	B	C	D
13079250 Culti-base 25L	50 mm	326 mm	326 mm	405 mm
13079300 Culti-base 30L	50 mm	326 mm	326 mm	442 mm

GETPLANTLOGIC.COM



Plastic gutter

Keeps ground free of water

Narrow and cheap gutter design collects 100% of the water waste.

Narrow gutter prevents clogging by dirt and old leaves, making it easier to clean.

Prevents contamination of the soil and aquifers due to chemical fertilizers.

Drainage collection helps control humidity in greenhouses.

Saves on water, fertilizer and fungicides.



Metal gutter

More resistant and durable than plastic gutters.

Does not bend nor deform.

Easier and faster to install.

No need for M stakes to maintain its shape.

Easier to clean and disinfect.

White color allows better visibility of the drainage.

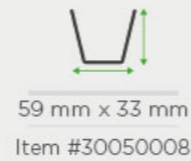
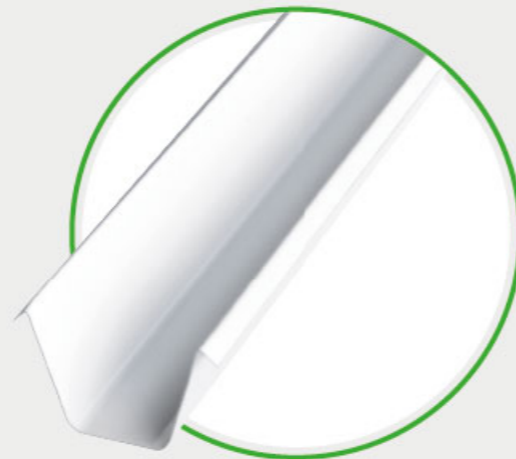

Add value to your products

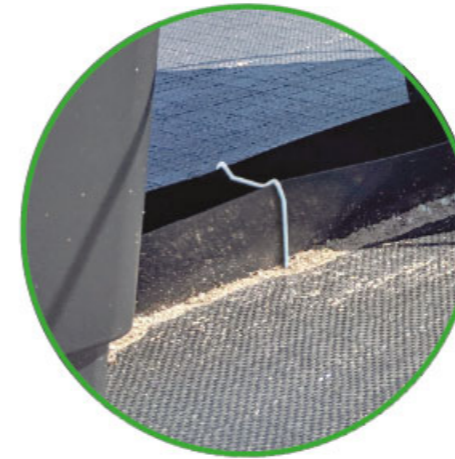

M-stakes for gutter

Keeps the gutter in place on uneven ground.

M-stake holds the sides of the gutter vertically.

M-stake ensures constant water flow.

Compatible with 5 cm / 2" wide gutter.



Item #1700146

Pot cover

Saves pruning labor by preventing raspberry sucker growth at the edge of the pot.

Stops unwanted weeds competing with your crop for water and nutrition.

Easily and securely locks to the pot to prevent being pushed off by weeds or suckers.

Keeps the irrigation hose in place.



Item #1310110



Item #13000910

Gutter cover

Prevents leaves, fruits and debris from falling into the gutter.

Slows algae growth.

Prevents drain evaporation and controls greenhouse humidity.

Gutter cover can be cut to size, then placed on top of the metal gutter, between the pots.



Microtube stake

Easy to place the micro tube with or without dripper.

*Save money on stakes using your current fertigation system.

Barbs help hold the stake securely in the substrate.

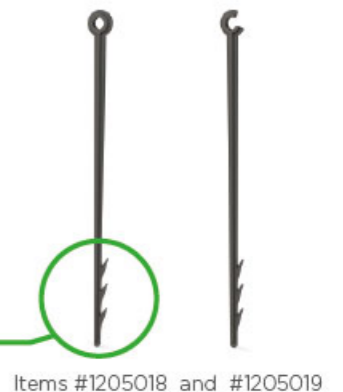

Items #1205018 and #1205019